

New Parts to fit Tuttnauer Automatic Autoclaves!

Models: EZ9, EZ10, EZ10k, 1730E/EK, 2340E/EA/EK/EKA, 2540E/EA/EHS/EK/EKA & 3870EHS



Introducing the Diagnostic Smart Kit® For Servicing Tuttnauer® Automatic Autoclaves
RPI Part #TUK108 (OEM Part #TEST-9)

- Calibrate/verify displayed pressure values.
- Calibrate/verify the Temperature Sensor values.
- Check and monitor all test point values from the AJUNC or ANL boards.
- Plus, Kit includes a durable plastic case and a troubleshooting information booklet.

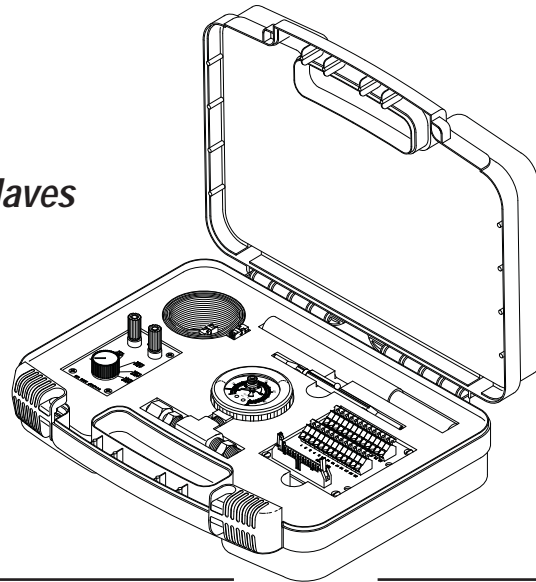

Kit includes all parts below!

RPI Part #TUT114
OEM Part #TEST-7

SIMULATOR (PT100)

- For Temperature Sensor calibration (simulates high and low temperatures)
- Use with Wire Harness No. 1, 2, or 3 (RPI Part #TUH111, TUH112, or TUH113) depending on the model number.

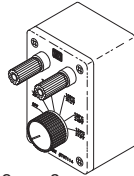

RPI Part #TUH111
OEM Part # (No OEM Part # Available)

WIRE HARNESS (No. 1)

- Small-sized 2 Pin Connector without jumper
- Use with Simulator (PT100) (RPI Part #TUT114)

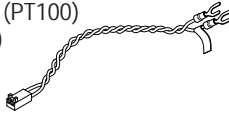

RPI Part #TUH112
OEM Part # (No OEM Part # Available)

WIRE HARNESS (No. 2)

- Medium-sized 2 Pin Connector without jumper
- Use with Simulator (PT100) (RPI Part #TUT114)

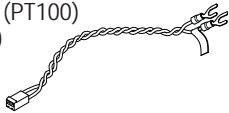

RPI Part #TUH113
OEM Part # (No OEM Part # Available)

WIRE HARNESS (No. 3)

- Large-sized 3 Pin Connector with jumper
- Use with Simulator (PT100) (RPI Part #TUT114)

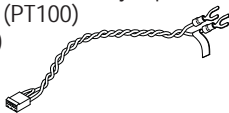

RPI Part #TUG110
OEM Part #TEST-2

PRESSURE GAUGE (TEST)

- See reverse side for more information

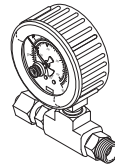

RPI Part #TUB109
OEM Part #TEST-1

TEST POINT BOARD

- Use with Ribbon Cable (RPI Part #TUC117)

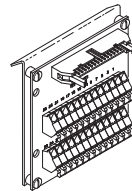

RPI Part #TUC117
OEM Part # (No OEM Part # Available)

RIBBON CABLE

- Use with Test Point Board (RPI Part #TUB109)



RPI Part #RPT460
OEM Part # (No OEM Part # Available)

TRIM POT ADJUSTMENT TOOL

- 5" Long; Plastic with stainless steel blades

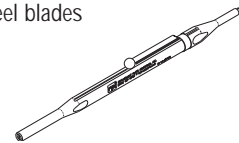

RPI Part #RPT113
OEM Part # (No OEM Part # Available)

MAX REGISTER THERMOMETER

- Use for temperature verification in sterilizers



RPI Part #RPC476
OEM Part # (No OEM Part # Available)

CARRYING CASE

- Includes "Pick-n-Pluck" foam insert

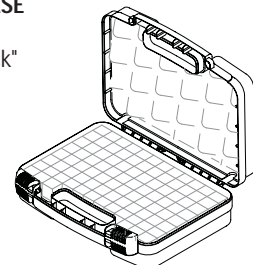
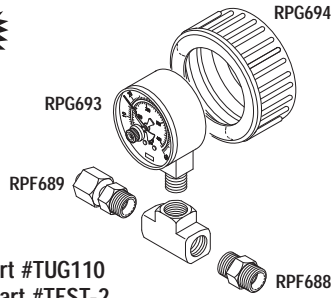

Table Top Sterilizers

Models: EZ9, EZ10, EZ10k, 1730, 2340, 2540 & 3870 Series



RPI Part #TUG110
OEM Part #TEST-2

PRESSURE GAUGE (TEST)

- Includes all parts listed below:
 - Pressure Gauge (RPI Part #RPG693)**
 - Dual scale: 0-60 PSI/0-400 kpa
 - Maximum indicating pointer for highest PSI reading
 - Gauge Guard (RPI Part #RPG694)**
 - Soft rubber; Color: Blue
 - Male Connector (RPF688)**
 - 1/4 MPT x 3/16" Brass Compression Fitting
 - Tube Adapter (RPI Part #RPF689)**
 - 1/4 MPT x 3/16" Brass Compression Tube
 - Includes (1) piece each: Compression Nut (RPI Part #RPF219) and Compression Sleeve (RPI Part #RPF215)

- All parts also sold separately
- Also included in Diagnostic Smart Kit® (RPI Part #TUK108)

Fits: Chamber manifold
Models: EZ9, EZ10, EZ10k, 1730E/EK, 2340E/EA/EK/EKA, 2540E/EA/EK/EKA & 3870EHS

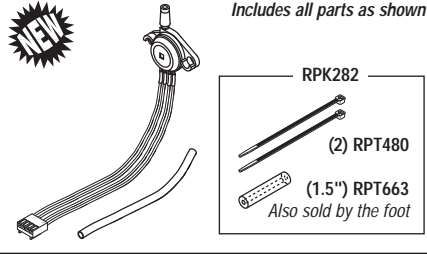

RPI Part #TUT092
OEM Part #01630101(AJUNC 2 PCB)/
01630101-1 (AJUNC 3 PCB)

PRESSURE TRANSDUCER

- Fits units with AJUNC 3 PCB; and can be easily modified to fit units with AJUNC 2 PCB
- Includes Pressure Tube Kit (RPI Part #PRK282)
- Fits:** AJUNC 2 PCB & AJUNC 3 PCB
- Models:** EZ9, EZ10, EZ10k, 1730E/EK, 2340E/EA/EK/EKA, 2540E/EA/EK/EKA & 3870E/EA

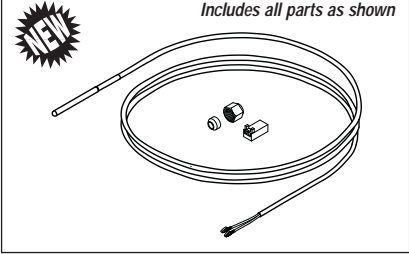

RPI Part #TUS093
OEM Part #01610501

TEMP SENSOR (PT100)

- Fits: Chamber Manifold AJUNC 3 PCB at the J11 connector
- Models:** EZ9, EZ10, EZ10k, 1730E/EK, 2340E/EA/EKA, & 2540E/EA/EKA

*Machine must be calibrated after replacing Pressure Transducer or Temp Sensor.
For Diagnostic Smart Kit® see RPI Part #TUK108 on reverse side.*



RPI Part #TUP106
OEM Part #04400299

POWER SUPPLY

- Protek brand
- Fits:** Chassis
- Models:** EZ9, EZ10, 1730E, 2340E/EA/EK/EKA, 2540E/EA/EKA & 3870E/EA

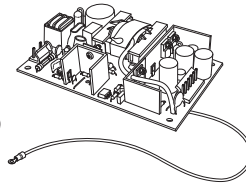

RPI Part #TUF103
OEM Part #FIL175-0006

FILTER SCREEN (New Style)

- .70" dia. x 1.26" lg.; S.S. mesh
- Fits:** Filter Cap Assembly
- Models:** 1730E/EK, 2340E/EA/EK/EKA, 2540E/EA/EK/EKA & 3870E/EA

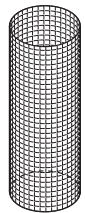

| RPI PART # | DESCRIPTION |
|------------|-----------------------|
| RPC476 | CARRYING CASE |
| RPF688 | MALE CONNECTOR |
| RPF689 | TUBE ADAPTER |
| RPG693 | PRESSURE GAUGE |
| RPG694 | GAUGE GUARD |
| RPK282 | PRESSURE TUBE KIT |
| RPT113 | MAX REGISTER THERM. |
| RPT460 | TRIM POT ADJUST. TOOL |
| TUB109 | TEST POINT BOARD |
| TUC117 | RIBBON CABLE |

| RPI PART # | DESCRIPTION |
|------------|---------------------------|
| TUF103 | FILTER SCREEN (NEW STYLE) |
| TUG110 | PRESSURE GAUGE (TEST) |
| TUH111 | WIRE HARNESS (NO. 1) |
| TUH112 | WIRE HARNESS (NO. 2) |
| TUH113 | WIRE HARNESS (NO. 3) |
| TUK108 | DIAGNOSTIC SMART KIT® |
| TUP106 | POWER SUPPLY |
| TUT092 | PRESSURE TRANSDUCER |
| TUT093 | TEMP SENSOR (PT100) |
| TUT114 | SIMULATOR (PT100) |

Look inside for new
Diagnostic Smart Kit®
to fit Tuttnauer
Automatic Autoclaves

ADDRESS SERVICES REQUESTED

PERMIT NO. 2399
VAN NUYS, CA
U.S. POSTAGE PAID
PRESORTED STANDARD

20338 Corisco Street • Chatsworth, California • 91311
replacement parts industries, inc.

