

Models: Statim 900 (#311101), 2000 (#1102 & 121101) & 5000 (#201103)

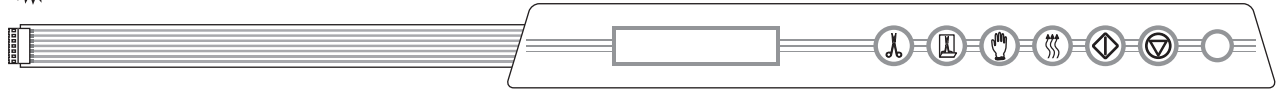

New Parts to fit **SciCan Statim®** Series Cassette Sterilizers



RPI Part #SCK040
OEM Part #01-109671
KEYPAD
Fits: Facia Cover
Model: 5000 model #01-201103



RPI Part #SCK041
OEM Part #01-109680S
KEYPAD
• 1 set of 2 pieces
Fits: Facia Cover
Model: 2000 model #01-121101 (New Type, Two Piece Style)



RPI Part #SCT030
OEM Part # (No OEM Part # Available)
THERMOCOUPLE
• Includes all parts as shown
Fits: Probe Bracket
Model: 2000 & 5000

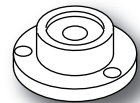
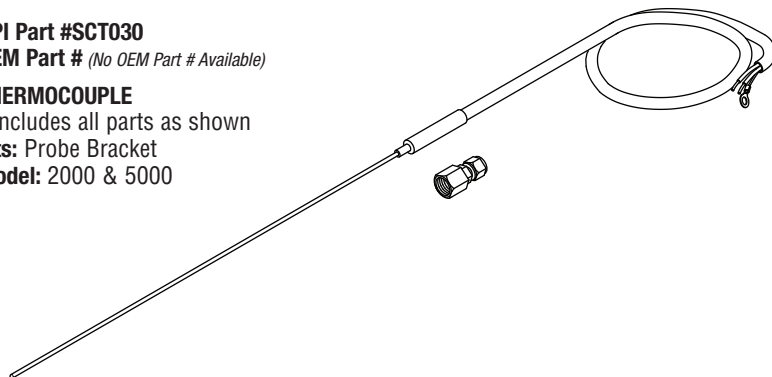

RPI Part #SCL012
OEM Part #01-100684S (Kit)
BUBBLE LEVEL
Fits: Housing Assemble
Model: 2000 & 5000

**More New Parts to fit
SciCan Statim Series
Cassette Sterilizers
on the Back!**



replacement parts industries, inc.

CALL (800) 221-9723 • FAX (818) 882-7028 • EMAIL order@rpiparts.com • WEBSITE www.rpiparts.com

The above parts are manufactured by Replacement Parts Industries, Inc. to fit SCICAN equipment. All product names used in this document are trademarks or registered trademarks of their respective holders. Web 01/10

Table Top Sterilizers

Models: Statim 900 (#311101), 2000 (#1102 & 121101) & 5000 (#201103)



More New Parts to fit SciCan Statim® Series Cassette Sterilizers

RPI Part #SCK037

OEM Part #01-108152S (Kit), 01-106637S (Kit)

DRAIN KIT WITH PUMP FILTER

Includes:

- Cord Clip (RPI Part #ADC058)
- Barb Tee (RPI Part #RPB703)
- Cable Clamp (RPI Part #RPC701)
- Cable Holder (RPI Part #RPC702)
- Cable Tie (3 pieces) (RPI Part #RPT083)
- Drain Tubing Kit (RPI Part #RPK432)
- Female Quick Connect Fitting (RPI Part #RPF428)
- Hex Nut (RPI Part #RPH111)
- Silicone Tubing (RPI Part #RPT373)
- Water Filter (In-Line) (RPI Part #SCF034)



RPI Advantage: Replacement is easily detected with RPI's Clear Tubing and Filter. Draining is simplified with the addition of our Quick Disconnect System – Just attach the tubing and you are ready to drain!

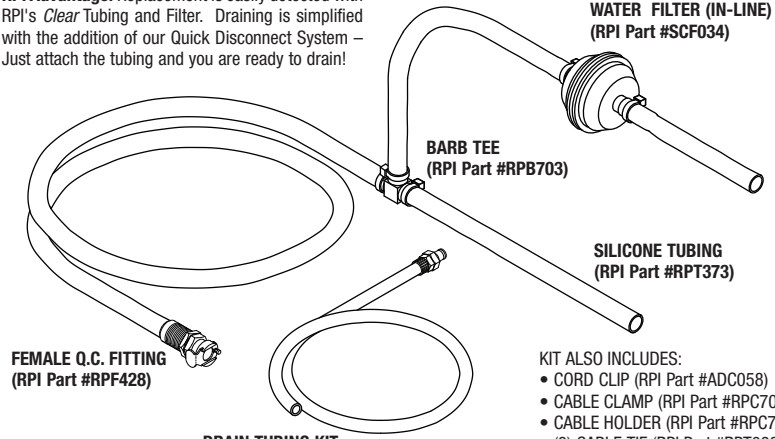

Fits: From the Reservoir to the Pump Filter to the Pump to the Drain Line

Model: 2000

KIT ALSO INCLUDES:

- CORD CLIP (RPI Part #ADC058)
- CABLE CLAMP (RPI Part #RPC701)
- CABLE HOLDER (RPI Part #RPC702)
- (3) CABLE TIE (RPI Part #RPT083)
- HEX NUT (RPI Part #RPH111)

RPI Part #RPB703

OEM Part #01-108152S (Kit)

BARB TEE (5/PKG)

- Nylon®; 3/16" Barb

Fits: Drain Tubing Kit

Model: 2000 & 5000

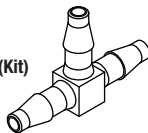

RPI Part #RPC702

OEM Part #01-108152S (Kit)

CABLE HOLDER (5/PKG)

- 3/8" ID flexible Nylon® loop

Fits: Drain Tubing Kit

Model: 2000 & 5000



RPI Part #RPC701

OEM Part #01-108152S (Kit)

CABLE CLAMP (5/PKG)

- Nylon®; for 1/4" OD cable

Fits: Drain Tubing Kit

Model: 2000 & 5000



RPI Part #ADC058

OEM Part # (No OEM Part # Available)

CORD CLIP (10/PKG)

- Nylon®; for 3/8" OD cable

Fits: Drain Tubing Kit

Model: 900, 2000 & 5000



RPI Part #SCF034

OEM Part #01-106637S

WATER FILTER (IN-LINE)

- Includes all parts as shown

• Also included in Drain Kit with Pump Filter (RPI Part #SCK037) and Sterilizer PM Kits (RPI Part #'s SCK035 & SCK036)

Fits: Water Pumps

Model: 900, 2000 & 5000

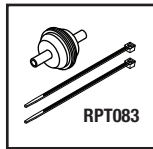

RPI Part #RPT373

OEM Part # (No OEM Part # Available)

SILICONE TUBING

- Sold by the foot (Reel not included)
- Translucent natural silicone
- 3/16" ID x 5/16" OD

Fits: Drain Tubing Kit

Model: 2000 & 5000



RPI Part #RPT083

OEM Part # (No OEM Part # Available)

CABLE TIE (4" WHITE)

- 25 per package
- Nylon®

Fits: Drain Tubing Kit

Model: 2000 & 5000



RPI Part #RPH111

OEM Part # (No OEM Part # Available)

HEX NUT (8-32)

- 50 per package
- Size: #8-32; stainless steel

Fits: Drain Tubing Kit

Model: 2000 & 5000

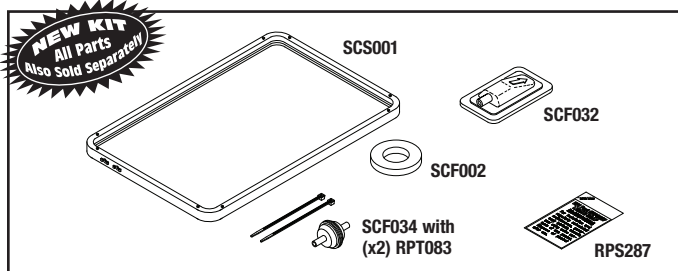

RPI Part #SCK035

OEM Part #01-100028S (Gasket Only)

STERILIZER PM KIT

Model: Statim 2000

Includes all parts as shown

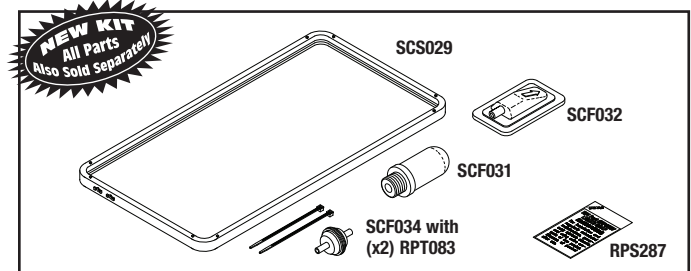

RPI Part #SCK036

OEM Part #01-101649S (Gasket Only)

STERILIZER PM KIT

Model: Statim 5000

Includes all parts as shown