

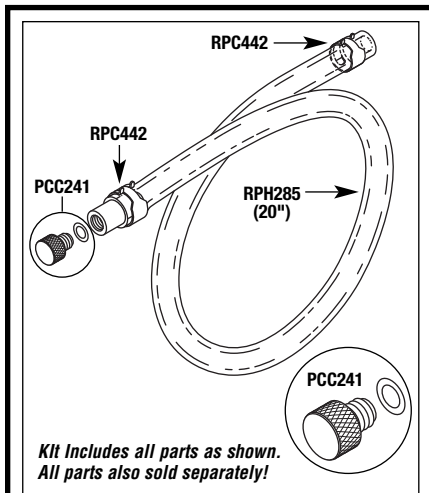

# RPI is your Source for parts to fit Pelton & Crane Magnaclave Sterilizers!

PELTON & CRANE



Kit Includes all parts as shown. All parts also sold separately!

**RPI Part #PCK240**  
OEM Part #004598, 004864, 004599, 005929, & 091007

**DRAIN KIT**  
Fits: Drain Adapter and Tube Assembly

Parts also sold separately:  
**RPI Part #PCC241**  
OEM Part #004598 (Cap) & 004864 (O-Ring)  
**DRAIN CAP WITH O-RING**  
• Includes O-Ring (RPI Part #RPO386)

**RPI Part #RPO386** (OEM Part #004864)  
O-RING - 6/PKG

**RPI Part #RPH285** (No OEM Part # Available)  
DRAIN HOSE - Sold by the foot

**RPI Part #RPC442** (No OEM Part # Available)  
UNICLAMP - 6/PKG

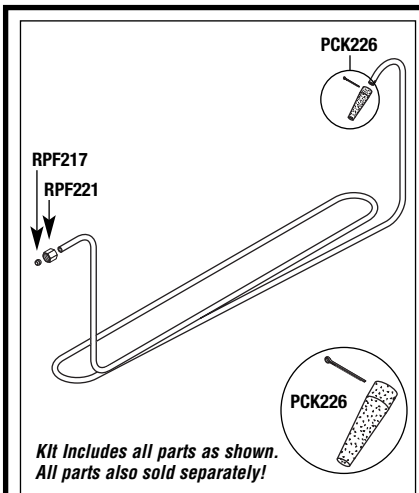

Kit Includes all parts as shown. All parts also sold separately!

**RPI Part #PCK238**  
OEM Part #004630 & A65-004630  
**CONDENSATION COIL KIT**  
Fits: Reservoir

Parts also sold separately:  
**RPI Part #RPF221** (No OEM Part # Available)  
COMPRESSION NUT - 5/pkg

**RPI Part #RPF217** (No OEM Part # Available)  
COMPRESSION SLEEVE - 5/pkg

**RPI Part #PCK226** (No OEM Part # Available)  
FILTER WITH COTTER PIN

The Filter With Cotter Pin (RPI Part #PCK226) is also included in the Sterilizer PM Kit (RPI Part #PCK216) – see page 2.

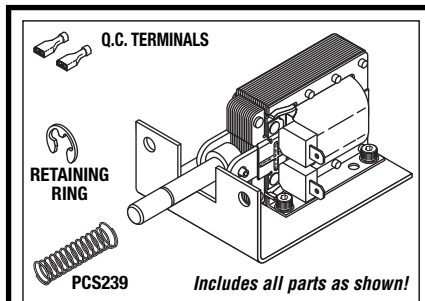

**RPI Part #PCK236**  
OEM Part #5473041  
**SOLENOID KIT (DOOR LATCH)**  
Fits: Door Locking Bracket

Part also sold separately:  
**RPI Part #PCS239**  
OEM Part #004525 & A63-004525  
**SPRING (DOOR INTERLOCK)**  
Fits: Door Lock Pin

**RPI Part #PCK242**  
OEM Part # (No OEM Part # Available)  
**BUSHING KIT (DOOR HINGE)**  
Fits: Door Support

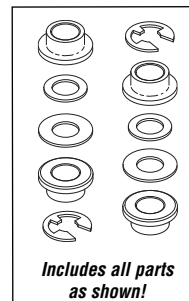

Includes all parts as shown!

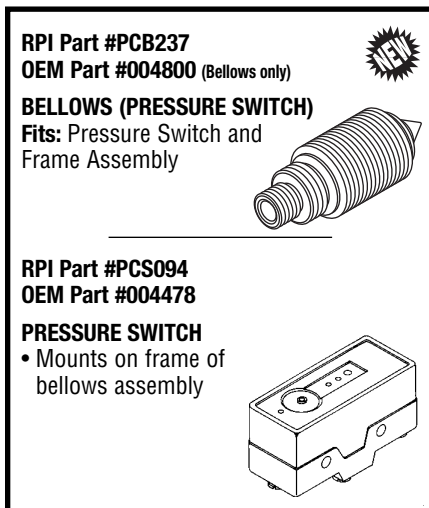

**RPI Part #PCB237**  
OEM Part #004800 (Bellows only)  
**BELLOWS (PRESSURE SWITCH)**  
Fits: Pressure Switch and Frame Assembly

**RPI Part #PCS094**  
OEM Part #004478  
**PRESSURE SWITCH**  
• Mounts on frame of bellows assembly

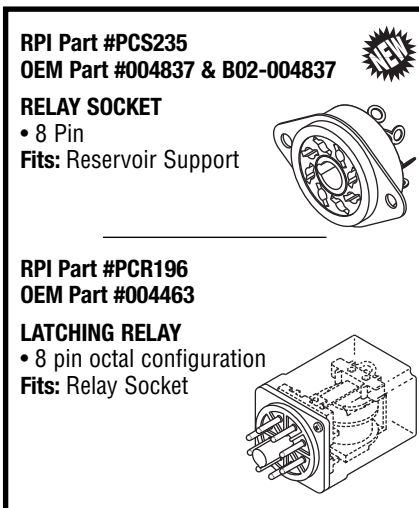

**RPI Part #PCS235**  
OEM Part #004837 & B02-004837  
**RELAY SOCKET**  
• 8 Pin  
Fits: Reservoir Support

**RPI Part #PCR196**  
OEM Part #004463  
**LATCHING RELAY**  
• 8 pin octal configuration  
Fits: Relay Socket

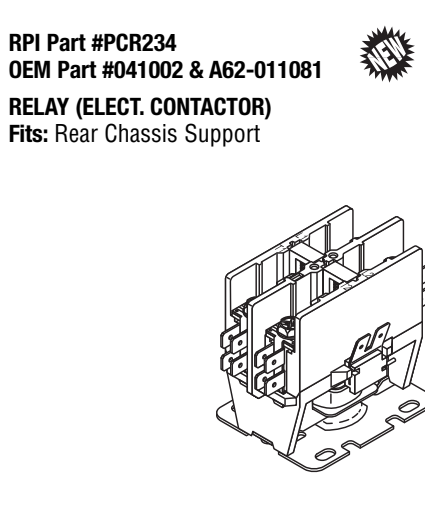

**RPI Part #PCR234**  
OEM Part #041002 & A62-011081  
**RELAY (ELECT. CONTACTOR)**  
Fits: Rear Chassis Support



replacement parts industries, inc.

CALL (800) 221-9723 • FAX (818) 882-7028 • EMAIL [order@rpiparts.com](mailto:order@rpiparts.com) • WEBSITE [www.rpiparts.com](http://www.rpiparts.com)

The above parts are manufactured by Replacement Parts Industries, Inc. to fit Pelton & Crane equipment. All product names used in this document are trademarks or registered trademarks of their respective holders. Web 03/11

# Table Top Sterilizers



## Parts to fit Pelton & Crane Magnaclave Sterilizers

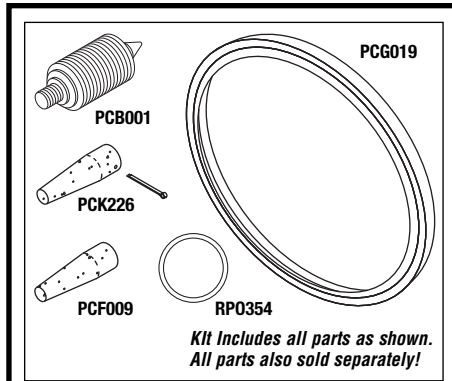

Kit Includes all parts as shown.  
All parts also sold separately!

**RPI Part #PCK216**  
**OEM Part #004497** (Door Gasket Only)  
**STERILIZER PM KIT**

*Parts also sold separately:*  
**RPI Part #PCG019** (OEM Part #004497)  
**DOOR GASKET**  
• 16.500" OD  
Fits: Door

**RPI Part #PCB001** (OEM Part #004048)  
**BELLOWS**  
Fits: Air Valve Housing

**RPI Part #PCK226** (No OEM Part # Available)  
**FILTER WITH COTTER PIN**  
Fits: Condensation Coil

**RPI Part #PCF009** (OEM Part #1881031 & 004326)  
**FILTER (FILL LINE)**  
Fits: Fill Tube

**RPI Part #RPO354** (OEM Part #004004)  
**AIR VALVE O-RING - 6/PKG**  
• .926" ID x 1.066" OD x .070" C/S; Silicone  
Fits: Air Valve Housing Bellows Cap

Download your Free  
Sterilizer PM Checklist  
from the RPI Tech Help page on  
our website – [www.rpiparts.com](http://www.rpiparts.com)

**RPI Part #PCT013**  
**OEM Part #004640**  
**FILL VENT TUBE**  
Fits: Fill Filter and Chamber

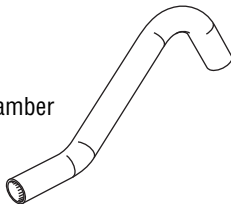

**RPI Part #RPT113**  
**OEM Part #** (No OEM Part # Available)

**MAX REGISTER THERMOMETER**  
• Mercury; Length: 5-1/2"  
• Use for temperature verification in sterilizer

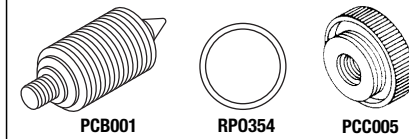
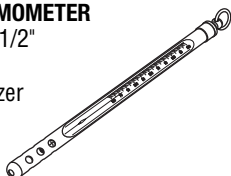

Kit Includes all parts as shown.  
All parts also sold separately!

**RPI Part #PCK224**  
**OEM Part #011047**  
**BELLOWS KIT**

*Parts also sold separately:*  
**RPI Part #PCB001** (OEM Part #004048)  
**BELLOWS**  
Fits: Air Valve Housing

**RPI Part #RPO354** (OEM Part #004004)  
**AIR VALVE O-RING - 6/PKG**  
• .926" ID x 1.066" OD x .070" C/S; Silicone  
Fits: Air Valve Housing Bellows Cap

**RPI Part #PCC005** (OEM Part #004228)  
**BELLOWS CAP**  
• Requires Air Valve O-Ring (RPI Part #RPO354)  
Fits: Air Valve Housing

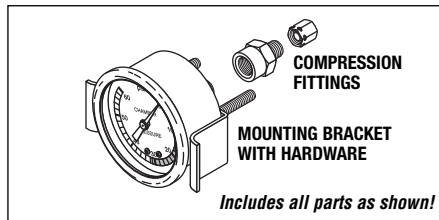

Includes all parts as shown!

**RPI Part #PCG040**  
**OEM Part #3336356 & 015316**

**PRESSURE GAUGE**  
• Dual Scale: 0 to 60 psi / 0 to 400 kpa  
Fits: Control Panel

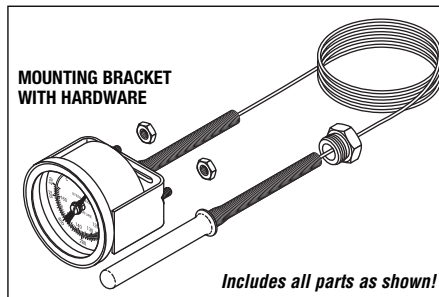

Includes all parts as shown!

**RPI Part #PCG079**  
**OEM Part #4207796 & 015363**

**TEMPERATURE GAUGE**  
• Dual scale: 100°F to 330°F / 94°C to 165°C  
• Capillary tubing length: 54"  
Fits: Control Panel

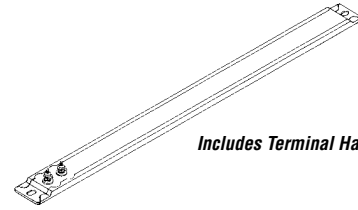

Includes Terminal Hardware!

**RPI Part #PCH091**  
**OEM Part #004515**

**MAIN HEATER STRIP (208VAC)**  
• 1 KW, 208 VAC, ~43Ω  
Fits: Chamber

**RPI Part #PCH089**  
**OEM Part #004516**

**WALL HEATER STRIP (208VAC)**  
• 500W, 208 VAC, ~87Ω  
Fits: Chamber

**RPI Part #PCH083**  
**OEM Part #004502**

**MAIN HEATER STRIP (240VAC)**  
• 1 KW, 240 VAC, ~58Ω  
Fits: Chamber

**RPI Part #PCH092**  
**OEM Part #004503**

**WALL HEATER STRIP (240VAC)**  
• 500 W, 240 VAC, ~115Ω  
Fits: Chamber

**RPI Part #PCT197**  
**OEM Part #004505**

**OVERHEAT THERMOSTAT SWITCH**  
• Switch opens @ 470°F ±20°F  
Fits: Mounting hole on heating element

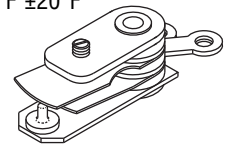

**RPI Part #PCT082**  
**OEM Part #004527**

**WALL THERMOSTAT**  
• Opens @ 245° F,  
Closes @ 215° F

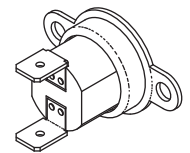

**RPI Part #PCV109**  
**OEM Part #004529**

**PRESSURE RELIEF VALVE**  
Fits: Chamber

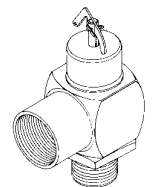

## Parts to fit Pelton & Crane Magnaclave Sterilizers



RPI Part #PCT081  
OEM Part #004531 & 041001

**ELECTRIC TIMER (60 MINUTE)**  
Fits: Control Panel

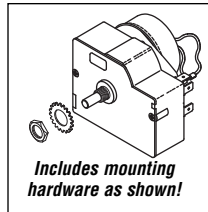

RPI Part #PCB088  
OEM Part #004491

**BUZZER**  
Fits: Mounts on machine Base

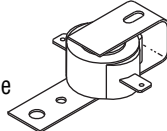

RPI Part #PCS043  
OEM Part #004079

**FUNCTION SWITCH (3 LEAD)**  
• Mounts to bracket in main valve assembly

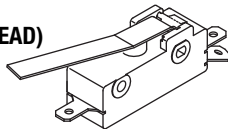

RPI Part #PCS044  
OEM Part #004073

**POWER SWITCH (2 LEAD)**  
• Mounts to bracket in main valve assembly

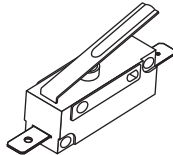

RPI Part #PCS090  
OEM Part #004545

**DOOR INTERLOCK SWITCH**  
• Mounts to bracket on door locking mechanism

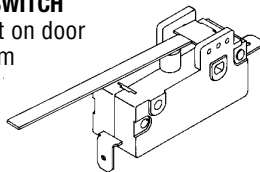

RPI Part #PCS086  
OEM Part #004468

**DOOR OPEN SWITCH**  
• Mounts to bracket on partition in reservoir area

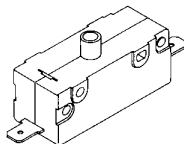

RPI Part #PCS087  
OEM Part #004461

**1 LB. PRESSURE SWITCH**  
• Mounts to bracket on one pound pressure switch assembly

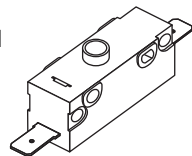

RPI Part #PCN136  
OEM Part #004076

**SPEEDNUT - 10/PKG**  
• "U" type #10-24 thread



Valve supplied with "Packings" pressed in!

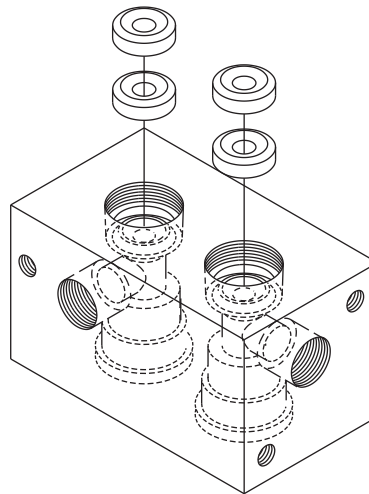

Includes all parts as shown!

RPI Part #PCV075  
OEM Part #004310

**MAIN VALVE BODY**  
• Valve supplied with "packings" pressed-in  
Fits: Main Valve Assembly

RPI Part #PCC073  
OEM Part #004030

**MAIN VALVE CAP**  
Fits: Main Valve



RPI Part #PCN072  
OEM Part #004027

**MAIN VALVE NUT**  
Fits: Main Valve



RPI Part #PCS074  
OEM Part #004028

**MAIN VALVE STEM**  
Fits: Main Valve

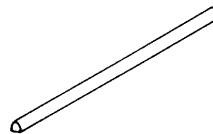

TO REPAIR VALVE,  
YOU WILL NEED  
(2) KITS!



Kit Includes all parts as shown.  
Parts also sold separately!

RPI Part #PCK026  
OEM Part #017706 (OEM has only 1 set)

**MAIN VALVE KIT**  
• To repair valve, need (2) Main Valve Kits (RPI Parts #PCK026)  
Fits: Main Valve

Parts also sold separately:  
RPI Part #PCR037 (OEM Part #004039)  
**VALVE BUTTON RETAINER**  
Fits: Main Valve

RPI Part #RP0355 (OEM Part #004000)  
**MAIN VALVE O-RING - 6/PKG**  
• .801" ID x .941" OD x .070" C/S; Silicone  
Fits: Main Valve

RPI Part #PCA118  
OEM Part #004231

**LOCATOR ARM - 3/pkg**  
• Mounts to Main Valve

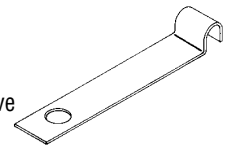

RPI Part #PCL029  
OEM Part #004501

**LAMP (OPEN DOOR)**  
Fits: Control Panel

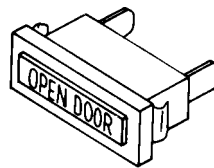

RPI Part #PCL030  
OEM Part #004499

**LAMP (HEAT ON)**  
Fits: Control Panel

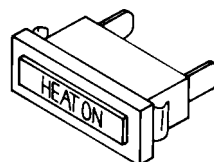

RPI Part #PCL031  
OEM Part #004500

**LAMP (STERILE)**  
Fits: Control Panel

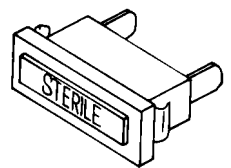

RPI Part #PCL032  
OEM Part #004498

**LAMP (POWER ON)**  
Fits: Control Panel

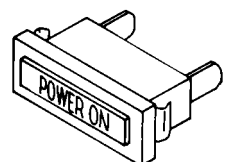



## List of Parts to fit Pelton & Crane Magnaclave Sterilizers

RPI Part #	OEM Part #	Description
PCA118	004231	Locator Arm - 3/pkg
PCB001	004048	Bellows
PCB088	004491	Buzzer
<b>PCB237</b>	004800 (Bellows Only)	Bellows (Pressure Switch)
PCC005	004228	Bellows Cap
PCC073	004030	Main Valve Cap
<b>PCC241</b>	004598 (Cap) & 004864 (O-Ring)	Drain Cap With O-ring
PCF009	1881031 & 004326	Filter (Fill-Line)
PCG019	004497	Door Gasket
PCG040	3336356 & 015316	Pressure Gauge
PCG079	4207796 & 015363	Temperature Gauge
PCH083	004502	Main Heater Strip (240VAC)
PCH089	004516	Wall Heater Strip (208VAC)
PCH091	004515	Main Heater Strip (208VAC)
PCH092	004503	Wall Heater Strip (240VAC)
PCK026	017706 (OEM has only 1 set)	Main Valve Kit
PCK216	004497 (Door Gasket Only)	Sterilizer PM Kit
PCK224	011047	Bellows Kit
PCK226	<i>OEM Part # Not Available</i>	Filter with Cotter Pin
<b>PCK236</b>	5473041	Solenoid Kit (Door Latch)
<b>PCK238</b>	004630 & A65-004630	Condensation Coil Kit
<b>PCK240</b>	004598, 004864, 004599, 005929 & 091007	Drain Kit
<b>PCK242</b>	<i>OEM Part # Not Available</i>	Bushing Kit (Door Hinge)
PCL029	004501	Lamp (Open Door)
PCL030	004499	Lamp (Heat On)
PCL031	004500	Lamp (Sterile)
PCL032	004498	Lamp (Power On)

RPI Part #	OEM Part #	Description
PCN072	004027	Main Valve Nut
PCN136	004076	Speednut - 10/pkg
PCR037	004039	Valve Button Retainer
PCR196	004463	Latching Relay
<b>PCR234</b>	041002 & A62-011081	Relay (Elect. Contactor)
PCS043	004079	Function Switch (3 Lead)
PCS044	004073	Power Switch (2 Lead)
PCS074	004028	Main Valve Stem
PCS086	004468	Door Open Switch
PCS087	004461	1 LB. Pressure Switch
PCS090	004545	Door Interlock Switch
PCS094	004478	Pressure Switch
<b>PCS235</b>	004837 & B02-004837	Relay Socket
<b>PCS239</b>	004525 & A63-004525	Spring (Door Interlock)
PCT013	004640	Fill Vent Tube
PCT081	004531 & 041001	Electric Timer (60 Minute)
PCT082	004527	Wall Thermostat
PCT197	004505	Overheat Thermostat Switch
PCV075	004310	Main Valve Body
PCV109	004529	Pressure Relief Valve
RPC442	<i>OEM Part # Not Available</i>	Uniclamp - 6/pkg
RPF217	<i>OEM Part # Not Available</i>	Compression Sleeve - 5/pkg
RPF221	<i>OEM Part # Not Available</i>	Compression Nut - 5/pkg
RPH285	<i>OEM Part # Not Available</i>	Drain Hose - sold by the foot
RPO354	004004	Air Valve O-Ring - 6/pkg
RPO355	004000	Main Valve O-Ring - 6/pkg
RPO386	004864	O-Ring - 6/pkg
RPT113	<i>OEM Part # Not Available</i>	Max Register Thermometer

Visit our website [www.rpiparts.com](http://www.rpiparts.com) for more information about these parts.

RPI is your Best Source for  
parts to fit Pelton & Crane  
Magnaclave sterilizers!

ADDRESS SERVICES REQUESTED

RESORTED STANDARD  
U.S. POSTAGE PAID  
VAN NUYS, CA  
PERMIT NO. 2399

replacement parts industries, inc.  
20338 Corisco Street • Chatsworth, California • 91311

